

## KARTA PRODUKTU

Numer Katalogowy	780453606
Dane Techniczne	
Pojemność (Ah)	45Ah
Napięcie (V)	12V
Prąd rozruchowy (A)EN	360
Długość (mm) [L]	207
Szerokość (mm) [W]	175
Wysokość (mm) [H]	190
Waga (kg) +/- 10%	12,0
Układ połączeń	6 (Lewo +)
Końcówki	1
Mocowanie	B13
Wskaźnik naładowania	✓
Prąd ładowania	Ok. 1/10 pojemności znamionowej
Napięcie ładowania	14,8 V
Typ/ Technologia	Kwasowo-ołowiowy (Ca-Ca) / X-Classe

\*DOMYŚLNY ZAMIENNIK Varta: 5454130403122 (Sprawdź)

MASTER-SPORT Automobiltechnik (MS) GmbH  
Leopoldstr. 244 80807 München  
Tel: +48 18 35 35 475 E-mail: sekretariat@master-sport.de



ISO 9001



ISO IATF 16949\*



CERTIFIED



AEO



CERTIFIED



www.tecdoc.de



www.teccom.de

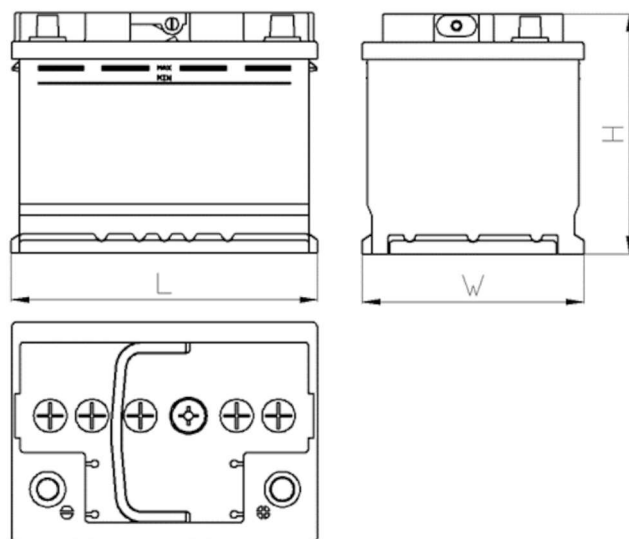

## TECHNICAL DATA SHEET

Catalog number	780453606
TECHNICAL DATA	
Capacity (Ah)	45Ah
Voltage (V)	12V
Cold cranking performance (A)EN	360
Length (mm) [L]	207
Width (mm) [W]	175
Height (mm) [H]	190
Weight (kg) +/- 10%	12,0
Connection layout	6 (Left +)
Tips	1
Base hold-down	B13
Charge indicator	✓
Charging current	Approx. 1/10 Rated Capacity
Charging voltage	14,8 V
Type / Technology	Lead-Acid (Ca-Ca) / X-Classe

\*DEFAULT REPLACEMENT Varta: 5454130403122 (Check)

MASTER-SPORT Automobiltechnik (MS) GmbH  
Leopoldstr. 244 80807 München  
Tel: +48 18 35 35 475 E-mail: sekretariat@master-sport.de



ISO 9001



ISO IATF 16949\*



CERTIFIED



AEO



CERTIFIED



www.tecdoc.de



www.teccom.de

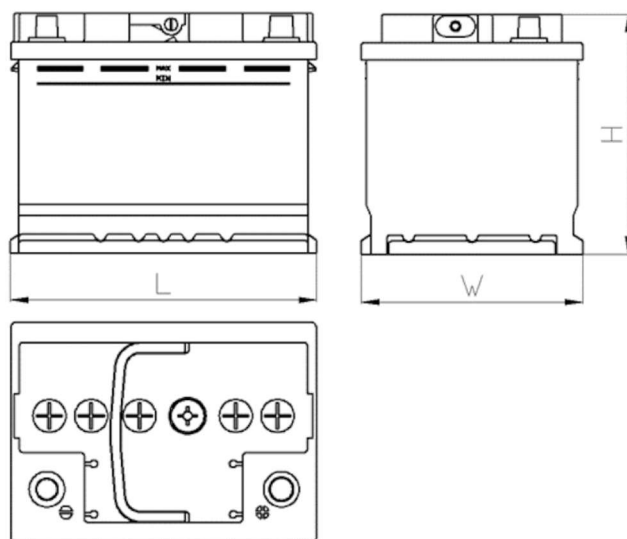

## TECHNISCHES DATENBLATT

Nummer	780453606
TECHNISCHE DATEN	
Nennkapazität (Ah)	45Ah
Nennspannung (V)	12V
Kaltstartstrom (A)EN	360
Länge (mm) [L]	207
Szerokość (mm) [W]	175
Höhe (mm) [H]	190
Batteriegewicht (kg ) +/- 10%	12,0
Polausführung	6 (Links +)
Schaltung	1
Bodenleiste	B13
Ladeanzeige	✓
Ladestrom	Ca. 1/10 Nennkapazität
Ladespannung	14,8 V
Typ / Technologie	Blei-Säure-Batterie (Ca-Ca) / X-Classe

\*STANDARD-ERSATZ Varta: 5454130403122 (Scheck)

MASTER-SPORT Automobiltechnik (MS) GmbH  
Leopoldstr. 244 80807 München  
Tel: +48 18 35 35 475 E-mail: sekretariat@master-sport.de



ISO 9001



ISO IATF 16949\*



CERTIFIED



AEO



CERTIFIED



www.tecdoc.de



www.teccom.de

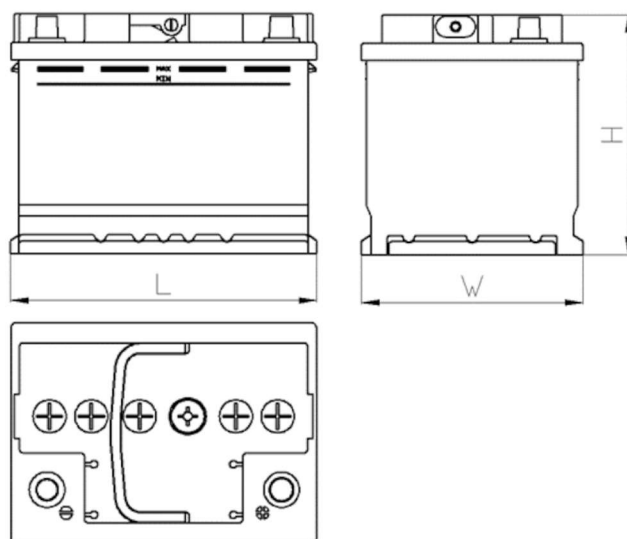

## SCHEDA PRODOTTO

Numero di catalogo	780453606
Dati tecnici	
Capacità (Ah)	45Ah
Tensione (V)	12V
Spunto (A)EN	360
Lunghezza (mm) [L]	207
Larghezza (mm) [W]	175
Altezza (mm) [H]	190
Peso (kg) +/- 10%	12,0
Sistema di connessione	6 (Sinistra +)
Estremità	1
Montaggio	B13
Indicatore di carica	✓
Corrente di carica	Circa 1/10 Capacità nominale
Tensione di carica	14,8 V
Tipo / Tecnologia	al Piombo-Acido (Ca-Ca) / X-Classe

\*Sostituto Varta: 5454130403122 (Controllare)

MASTER-SPORT Automobiltechnik (MS) GmbH  
Leopoldstr. 244 80807 München  
Tel: +48 18 35 35 475 E-mail: sekretariat@master-sport.de



ISO 9001



ISO IATF 16949\*



CERTIFIED



AEO



CERTIFIED



www.tecdoc.de



www.teccom.de

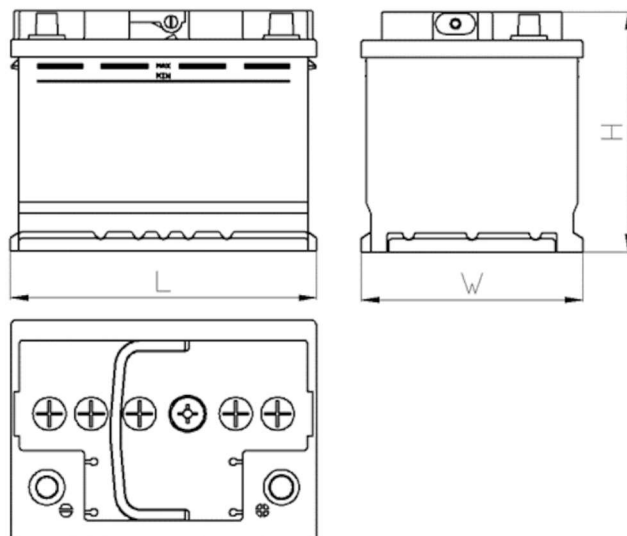

## Технические характеристики

Каталожный номер	780453606
Технические данные	
Емкость (Ач)	45Ah
Напряжение (В)	12V
Пусковой ток (А) EN	360
Длина (мм) [L]	207
Ширина (мм) [W]	175
Высота (мм) [H]	190
Вес (кг) +/- 10%	12,0
Система связи	6 (слева +)
концы	1
монтаж	B13
Индикатор заряда	✓
Зарядный ток	Прибл. 1/10 от номинальной мощности
Зарядное напряжение	14,8 V
Тип / Технология	Кислота-свинец (Ca-Ca) / X-Classe

\*Замена по умолчанию Varta: 5454130403122 (Проверить)

MASTER-SPORT Automobiltechnik (MS) GmbH  
Leopoldstr. 244 80807 München  
Tel: +48 18 35 35 475 E-mail: sekretariat@master-sport.de



ISO 9001



ISO IATF 16949\*



CERTIFIED



AEO



CERTIFIED



www.tecdoc.de



www.teccom.de

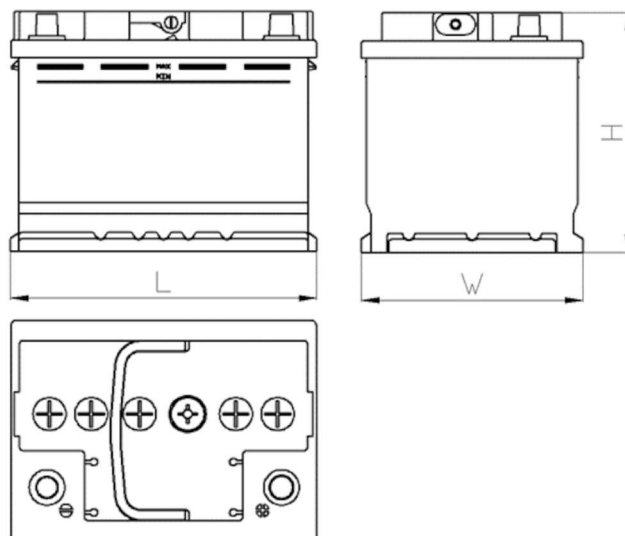

## Dátový hárok

Katalógové číslo	780453606
Technické údaje	
Kapacita (Ah)	45Ah
Napätie (V)	12V
Štartovací prúd (A) EN	360
Dĺžka (mm)	207
Šírka (mm)	175
Výška (mm)	190
Hmotnosť (kg) +/- 10%	12,0
Systém pripojenia	6 (Lewo +)
Koncovky	1
Montážne	B13
Indikátor nabitia	✓
Nabíjací prúd	Ok. 1/10 menovitej kapacity
Nabíjacie napätie	14,8 V
Typ / technológia	Kyselinovo -olovovy (Ca-Ca) / X-Classe

\*PREDVOLENÁ VÝMENA Varta: 5454130403122 (Check)

MASTER-SPORT Automobiltechnik (MS) GmbH  
Leopoldstr. 244 80807 München  
Tel: +48 18 35 35 475 E-mail: sekretariat@master-sport.de



ISO 9001



ISO IATF 16949\*



CERTIFIED



AEO



CERTIFIED



www.tecdoc.de



www.teccom.de