

## KARTA PRODUKTU

Numer Katalogowy	770506002
Dane Techniczne	
Pojemność (Ah)	50Ah
Napięcie (V)	12V
Prąd rozruchowy (A)EN	600
Długość (mm) [L]	207
Szerokość (mm) [W]	175
Wysokość (mm) [H]	190
Waga (kg) +/- 10%	14,7
Układ połączeń	2 (Prawo +)
Końcówki	1
Mocowanie	B13
Wskaźnik naładowania	x
Prąd ładowania	Ok. 1/10 pojemności znamionowej
Napięcie ładowania	14,8 V
Typ/ Technologia	Kwasowo-ołowiowy (Ca-Ca) / X-Classe

\*DOMYŚLNY ZAMIENNIK Varta: 545200030A742 (Sprawdź)

MASTER-SPORT Automobiltechnik (MS) GmbH  
Leopoldstr. 244 80807 München  
Tel: +48 18 35 35 475 E-mail: sekretariat@master-sport.de



ISO 9001



ISO IATF 16949\*



CERTIFIED



AEO



CERTIFIED



www.tecdoc.de



www.teccom.de

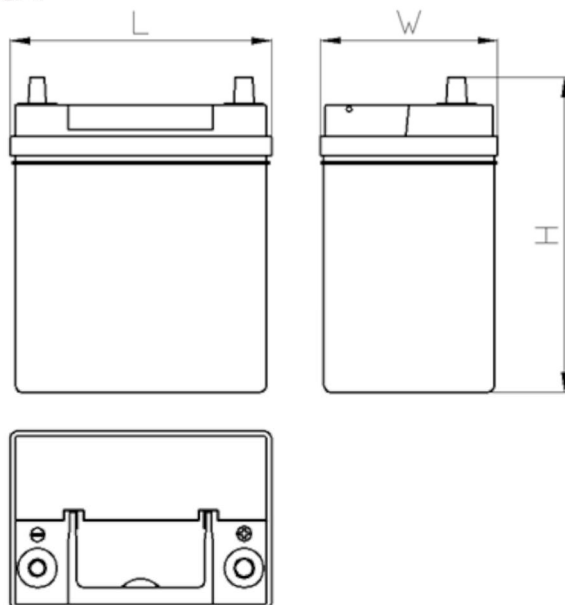

## TECHNICAL DATA SHEET

Catalog number	770506002
TECHNICAL DATA	
Capacity (Ah)	50Ah
Voltage (V)	12V
Cold cranking performance (A)EN	600
Length (mm) [L]	207
Width (mm) [W]	175
Height (mm) [H]	190
Weight (kg) +/- 10%	14,7
Connection layout	2 (Right +)
Tips	1
Base hold-down	B13
Charge indicator	x
Charging current	Approx. 1/10 Rated Capacity
Charging voltage	14,8 V
Type / Technology	Lead-Acid (Ca-Ca) / X-Classe

\*DEFAULT REPLACEMENT Varta: 545200030A742 (Check)

MASTER-SPORT Automobiltechnik (MS) GmbH  
Leopoldstr. 244 80807 München  
Tel: +48 18 35 35 475 E-mail: sekretariat@master-sport.de



ISO 9001



ISO IATF 16949\*



CERTIFIED



AEO



CERTIFIED



www.tecdoc.de



www.teccom.de

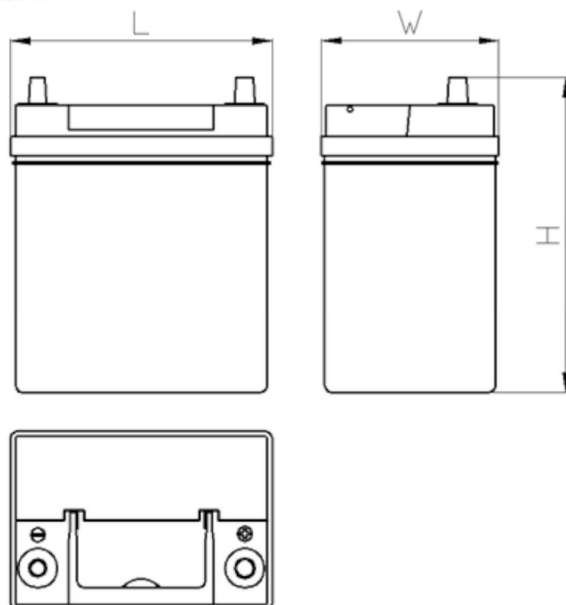

## TECHNISCHES DATENBLATT

Nummer	770506002
TECHNISCHE DATEN	
Nennkapazität (Ah)	50Ah
Nennspannung (V)	12V
Kaltstartstrom (A)EN	600
Länge (mm) [L]	207
Szerokość (mm) [W]	175
Höhe (mm) [H]	190
Batteriegewicht (kg ) +/- 10%	14,7
Polausführung	2 (Rechts +)
Schaltung	1
Bodenleiste	B13
Ladeanzeige	x
Ladestrom	Ca. 1/10 Nennkapazität
Ladespannung	14,8 V
Typ / Technologie	Blei-Säure-Batterie (Ca-Ca) / X-Classe

\*STANDARD-ERSATZ Varta: 545200030A742 (Scheck)

MASTER-SPORT Automobiltechnik (MS) GmbH  
Leopoldstr. 244 80807 München  
Tel: +48 18 35 35 475 E-mail: sekretariat@master-sport.de



ISO 9001



ISO IATF 16949\*



CERTIFIED



AEO



CERTIFIED



www.tecdoc.de



www.teccom.de

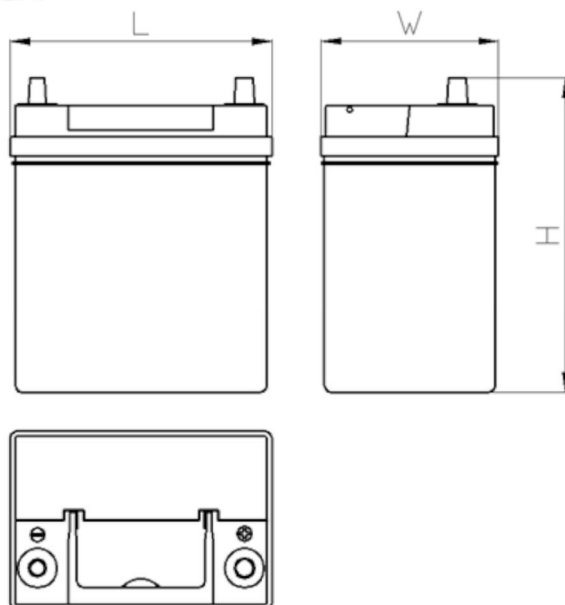

## SCHEDA PRODOTTO

Numero di catalogo	770506002
Dati tecnici	
Capacità (Ah)	50Ah
Tensione (V)	12V
Spunto (A)EN	600
Lunghezza (mm) [L]	207
Larghezza (mm) [W]	175
Altezza (mm) [H]	190
Peso (kg) +/- 10%	14,7
Sistema di connessione	2 (Destra +)
Estremità	1
Montaggio	B13
Indicatore di carica	x
Corrente di carica	Circa 1/10 Capacità nominale
Tensione di carica	14,8 V
Tipo / Tecnologia	al Piombo-Acido (Ca-Ca) / X-Classe

\*Sostituto Varta: 545200030A742 (Controllare)

MASTER-SPORT Automobiltechnik (MS) GmbH  
Leopoldstr. 244 80807 München  
Tel: +48 18 35 35 475 E-mail: sekretariat@master-sport.de



ISO 9001



ISO IATF 16949\*



CERTIFIED



AEO



CERTIFIED



www.tecdoc.de



www.teccom.de

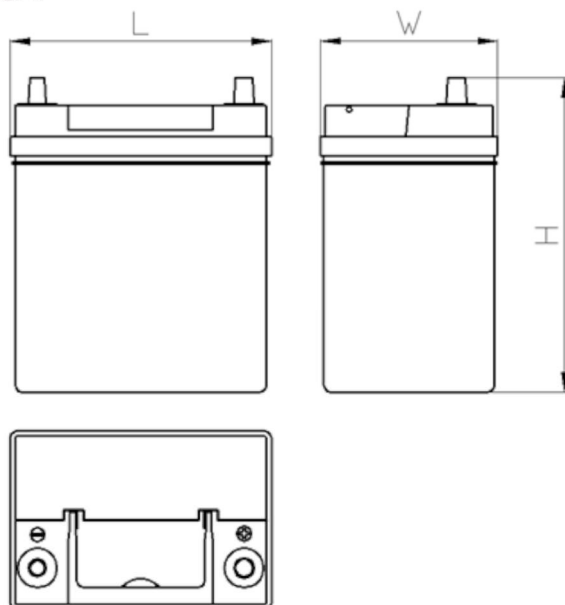

## Технические характеристики

Каталожный номер	770506002
Технические данные	
Емкость (Ач)	50Ah
Напряжение (В)	12V
Пусковой ток (А) EN	600
Длина (мм) [L]	207
Ширина (мм) [W]	175
Высота (мм) [H]	190
Вес (кг) +/- 10%	14,7
Система связи	2 (право +)
концы	1
монтаж	B13
Индикатор заряда	x
Зарядный ток	Прибл. 1/10 от номинальной мощности
Зарядное напряжение	14,8 V
Тип / Технология	Кислота-свинец (Ca-Ca) / X-Classe

\*Замена по умолчанию Varta: 545200030A742 (Проверить)

MASTER-SPORT Automobiltechnik (MS) GmbH  
Leopoldstr. 244 80807 München  
Tel: +48 18 35 35 475 E-mail: sekretariat@master-sport.de



ISO 9001



ISO IATF 16949\*



CERTIFIED



AEO



CERTIFIED



www.tecdoc.de



www.teccom.de

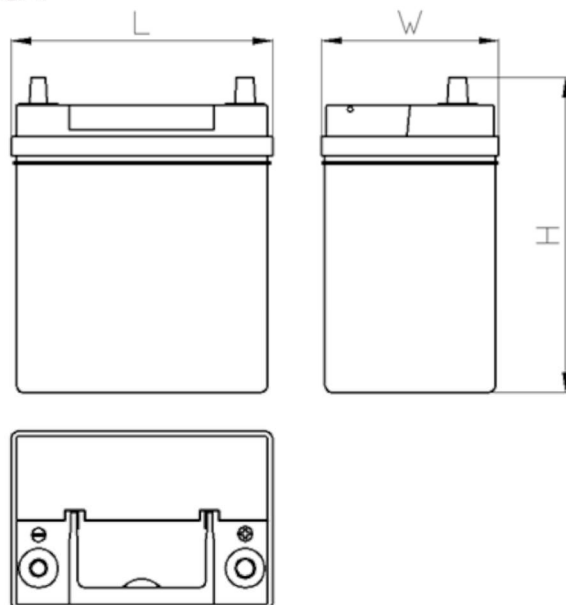

## Dátový hárok

Katalógové číslo	770506002
Technické údaje	
Kapacita (Ah)	50Ah
Napätie (V)	12V
Štartovací prúd (A) EN	600
Dĺžka (mm)	207
Šírka (mm)	175
Výška (mm)	190
Hmotnosť (kg) +/- 10%	14,7
Systém pripojenia	2 (Pravo +)
Koncovky	1
Montážne	B13
Indikátor nabitia	x
Nabíjací prúd	Ok. 1/10 menovitej kapacity
Nabíjacie napätie	14,8 V
Typ / technológia	Kyselinovo - olovovy (Ca-Ca) / X-Classe

\*PREDVOLENÁ VÝMENA Varta: 545200030A742 (Check)

MASTER-SPORT Automobiltechnik (MS) GmbH  
Leopoldstr. 244 80807 München  
Tel: +48 18 35 35 475 E-mail: sekretariat@master-sport.de



ISO 9001



ISO IATF 16949\*



CERTIFIED



AEO



CERTIFIED



www.tecdoc.de



www.teccom.de